



IP2163EN • 2020-11-26



Ditec CS12M

Control panel installation manual for Ditec NEOS+ automations

(Translation of the original instructions)

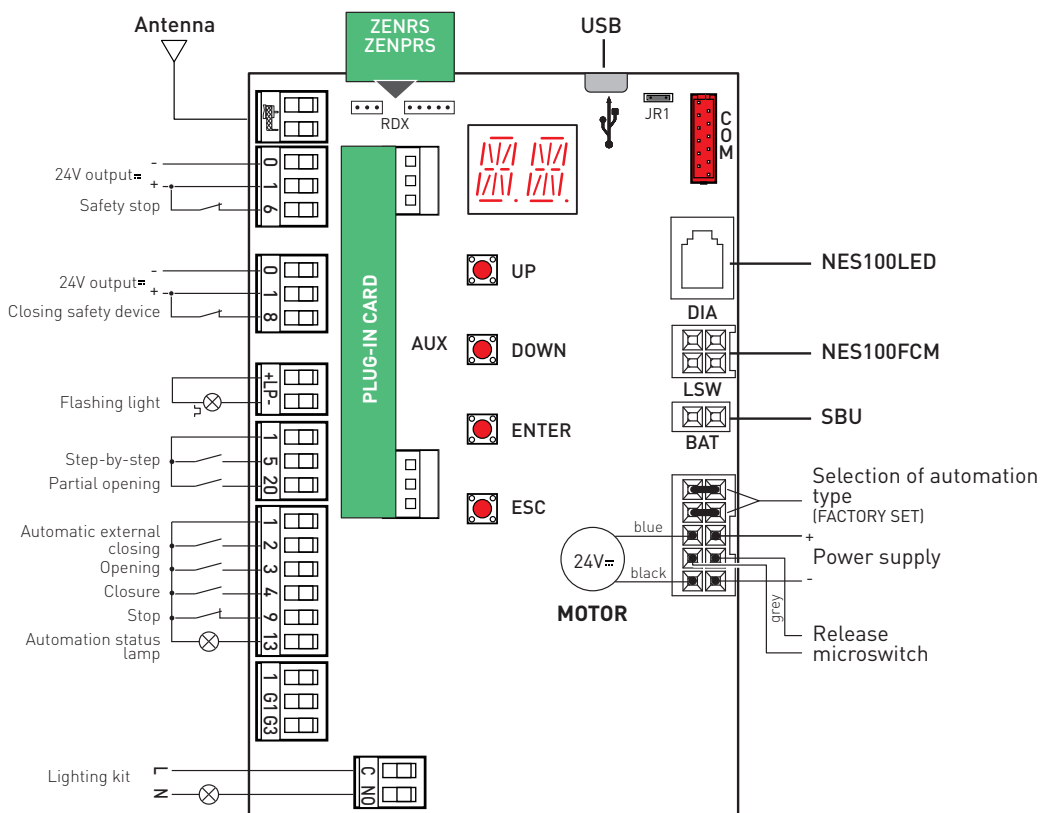

Contents

	Subject	Page
1.	General safety precautions	3
2.	EC Declaration of Conformity	4
3.	Technical specifications	4
4.	Commands	5
4.1	Inserting plug-in card (AUX)	6
4.2	Self-controlled safety edge	6
5.	Outputs and accessories	8
6.	Selections	10
7.	Adjustments	11
7.1	Switching on and off	11
7.2	Key combinations	12
7.3	Main menu	13
7.4	Second level menu - AT (Automatic Configurations)	14
7.5	Second level menu - BC (Basic Configurations)	16
7.6	Second level menu - BA (Basic Adjustment)	18
7.7	Second level menu - RO (Radio Operations)	22
7.8	Second level menu - SF (Special Functions)	22
7.9	Second level menu - CC (Cycles Counter)	27
7.10	Second level menu - EM (Energy Management)	29
7.11	Second level menu - AP (Advanced Parameters)	31
8.	Display visualisation mode	37
8.1	Display of automation status	37
8.2	Display of safety devices and commands	39
8.3	Display of alarms and faults	41
9.	Start-up	45
10.	Troubleshooting	46
11.	Examples of application	48
12.	Examples of applications for parallel automations	50
13.	Examples of application for automations with two-way interlocking device without presence detection	51
14.	Examples of application for automations with two-way interlocking device with presence detection	52

Key



This symbol indicates instructions or notes regarding safety, to which special attention must be paid.



This symbol indicates useful information for the correct functioning of the product.



Factory settings

1. General safety precautions



Failure to observe the information given in this manual may lead to personal injury or damage to the equipment.
Keep these instructions for future reference

This installation manual is intended for qualified personnel only. Installation, electrical connections and adjustments must be performed in accordance with Good Working Methods and in compliance with the present standards. This product must only be used for the specific purpose for which it was designed. Any other use is to be considered improper and therefore dangerous. The manufacturer cannot be held responsible for any damage caused by improper, incorrect or unreasonable use. Read the instructions carefully before installing the product. Incorrect installation could be dangerous.



The packaging materials (plastic, polystyrene, etc.) should not be discarded in the environment or left within reach of children, as they are a potential source of danger.

Before installing the product, make sure it is in perfect condition.

Do not install the product in explosive areas and atmospheres: the presence of inflammable gas or fumes represents a serious safety hazard.

The safety devices (photocells, safety edges, emergency stops, etc.) must be installed taking into account the applicable laws and directives, Good Working Methods, installation premises, system operating logic and the forces developed by the automation. Before connecting the power supply, make sure the plate data correspond to those of the mains power supply. An omnipolar disconnection switch with a contact opening distance of at least 3 mm must be fitted on the mains supply.

Check that there is an adequate residual current circuit breaker and a suitable overcurrent cut-out upstream of the electrical installation in accordance with Good Working Methods and with the laws in force.

When requested, connect the automation to an effective earthing system that complies with current safety standards.



During installation, maintenance and repair operations, cut off the power supply before opening the cover to access the electrical parts.



The electronic parts must be handled using earthed antistatic conductive arms. The manufacturer of the motorisation device declines all responsibility if component parts not compatible with safe and correct operation are fitted.

Only use original spare parts when repairing or replacing products.

1.1 Safety functions

The CS12M control panel has the following safety functions:

- obstacle recognition with force limiting;

The maximum response time of the safety functions is 0.5 s. The reaction time to a faulty safety function is 0.5 s.

The safety functions comply with the standards and performance level indicated below:

EN ISO 13849-1:2008 Category 2 PL=c
EN ISO 13849-2:2012

The safety function cannot be bypassed either temporarily or automatically. Fault exclusion has not been applied.

2. EC Declaration of Conformity

The manufacturer Entrematic Group AB, with headquarters in Lodjursgatan 10, SE-261 44 Landskrona, Sweden, declares that the Ditec CS12M type control panel complies with the conditions of the following EC directives:

2014/30/EU (EMCD)

2014/35/EU (LVD)









2014/53/EU (RED)

Landskrona, 2020-11-26

Matteo Fino
President & CEO



3. Technical specifications

	NES300EHP	NES400EHP	NES600EHP	NES600EHP
Power	230V~ 50/60Hz	230V~ 50/60Hz	230V~ 50/60Hz	230V~ 50/60Hz
Motor output	24V $\overline{=}$ 12A max	24V $\overline{=}$ 14A max	24V $\overline{=}$ 16A max	24V $\overline{=}$ 20A max
Power supply for accessories	24V $\overline{=}$ 0,3A max	24V $\overline{=}$ 0,3A max	24V $\overline{=}$ 0,3A max	24V $\overline{=}$ 0,3A max
Usage temperature	 -20°C  +55°C	 -20°C  +55°C	 -20°C  +55°C	 -20°C  +55°C
Storable radio codes	100 200 [BIXMR2]	100 200 [BIXMR2]	100 200 [BIXMR2]	100 200 [BIXMR2]
Radio frequency	433,92MHz	433,92MHz	433,92MHz	433,92MHz



NOTE: the given operating and performance features can only be guaranteed with the use of DITEC accessories and safety devices.

4. Commands

Command	Function	Description
1 — 2 NO	AUTOMATIC CLOSING	Permanent closing of the contact enables automatic closing if AC → I-2
1 — 3 NO	OPENING	Closing of the contact activates an opening operation.
1 — 4 NO	CLOSING	Closing of the contact activates a closing operation.
1 — 5 NO	STEP-BY-STEP	When selecting BC → CS → I-5 , closing the contact starts a sequential opening or closing operation: opening-stop-closing-opening. WARNING: if automatic closing is enabled, the duration of the stop can be selected by selecting BC → SS . The sequence "opening-stop-closing-opening" can be changed to "opening-stop-closing-stop-opening" BC → PP .
	OPENING	When selecting BC → CS → I-3 , closing the contact activates an opening operation.
1 — 6 NC	SAFETY STOP	The opening of the safety contact stops and prevents any movement. NOTE: to set different safety contact functions, see the AP → SM parameter settings.
1 — 8 NC	CLOSING SAFETY DEVICE	Opening the safety contact triggers a reversal of the movement (reopening) during the closing operation. When selecting BC → SO → ON , with the automation idle, opening of the contact prevents any operation. When selecting BC → SO → OF , with the automation idle, opening of the contact only prevents closing.
1 — 9 NC	STOP	Opening of the safety contact causes the movement to stop and automatic closing is disabled. In this state, the opening (1-3/1-20) and closing (1-4) controls function only if held in the pressed position and the automation stops when the controls are released.
1 — 9 NC	EMERGENCY STOP	Connect the opening and closing controls to terminal 9 instead of terminal 1 (9-3, 9-4, 9-20) Opening of the safety contact (for example, connected to an emergency command) causes the movement to stop and additional commands are disabled.
1 — 9 NO	COMMAND WITH OPERATOR PRESENT	Opening of contact 1-9 enables the operator present function. - opening with operator present 1-3; - closing with operator present 1-4; - partial opening with operator present 1-20. NOTE: any safety devices, automatic closing and plug-in cards inserted in the AUX housing are disabled.
1 — 20 NO	PARTIAL OPENING	Closing of the contact activates a partial opening operation. Once the automation stops, the partial opening control performs the opposite operation to the one performed before the stop.





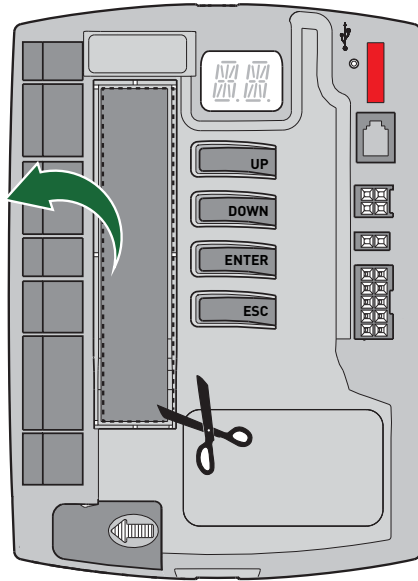

WARNING: make a jumper for all NC contacts if not in use. The terminals with the same number are equal.

4.1 Inserting plug-in card (AUX)

To access the plug-in card (AUX), cut the control panel cover as shown in the figure.









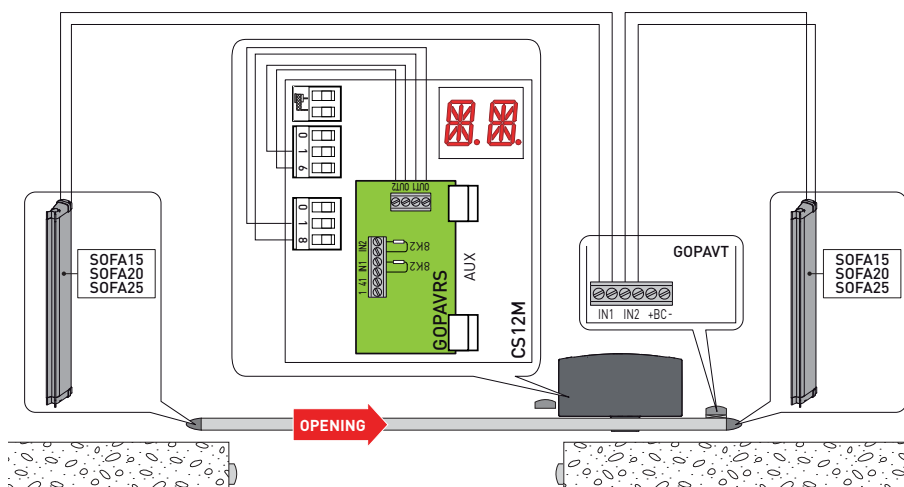
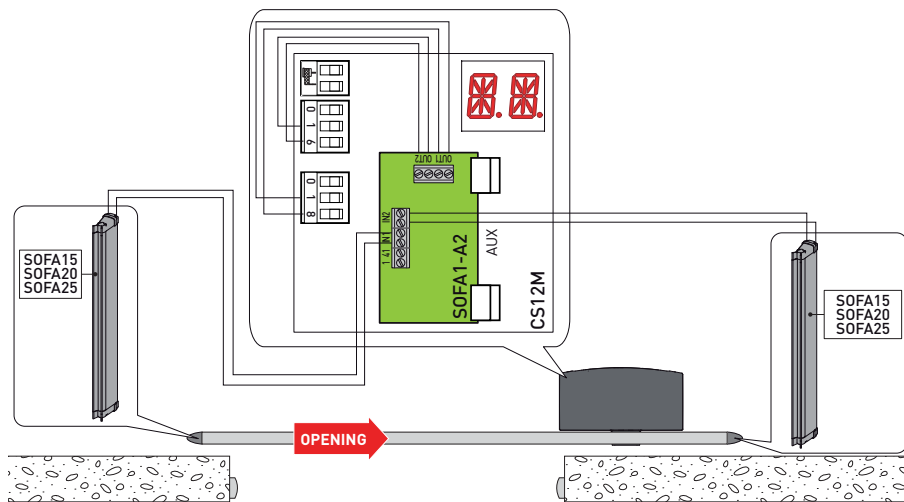

4.2 SOFA1-SOFA2 or GOPAVRS self-controlled safety edge



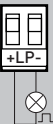
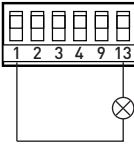



Command	Function	Description
<div style="background-color: #4CAF50; color: white; padding: 5px; text-align: center;"> SOFA1-SOFA2 GOPAV </div>  	SAFETY TEST	Place the SOFA1-SOFA2 or GOPAVRS device into the special housing for AUX plug-in cards. If the test fails, an alarm message appears on the display.
1  6	NC	SAFETY STOP
1  8	NC	CLOSING SAFETY DEVICE
		When selecting AP → DB → 54 , connect the output contact of the safety device to terminals 1-6 on the control panel (in series with the photocell output contact, if installed).
		When selecting AP → DB → 54 , connect the output contact of the safety device to terminals 1-8 on the control panel (in series with the photocell output contact, if installed).









Examples of installation of self-controlled safety edge



5. Outputs and accessories

Output	Value Accessories	Description
	24V \approx 0.3A	Power supply to accessories. External accessories power supply output. NOTE: the maximum absorption of 0.3A corresponds to the sum of all terminals 1. The gate open indicator light (1-13) is not calculated in the 0.3A indicated above, the maximum value considered is 3W.
	GOL148REA	If the GOL868R4 radio receiver is used (868.35 MHz), connect the supplied antenna wire (90mm).
	LAMPH 24V \approx 25W	Flashing light. The pre-flashing settings can be selected from the third level menu AP \rightarrow WD and/or AP \rightarrow WC .
	24V \approx 3W	Automation status lamp (proportional) The light comes on when the automation is open BC \rightarrow OL \rightarrow ON The light goes off when the automation is closed. The light flashes with a variable frequency while the automation is operating BC \rightarrow OL \rightarrow DF .
	10mA max	G1 - General Purpose Input Operating of the G1 input can be selected from the menu AP \rightarrow G 1 .
		G3 - General Purpose Output Operating of the G3 output depends on the type of G1 input selection. SY - If G 1 \rightarrow S Y , G3 operates as a sync output for parallel or interlocked automations. The ES - Energy Saving mode is not available with this configuration. 41 - If the safety test (S 41 or P 41) is enabled on at least one or both inputs IB 6 and IB 8 , G3 operates as a safety test output. 30 - In applications with solar panels, G3 operates as a permanent positive at 24V max 10mA to be connected with the NO contact to G1 (opening and/or step-by-step).
	230V~ 400 W	External courtesy light. An external courtesy light that turns on for 180 seconds with every opening (total or partial), step-by-step and closing command can be connected. The C-NO terminal can be accessed by removing the cover on the left-hand side at the bottom of the control panel. 
		 In order to comply with essential requirements of standards in force, reclose the cover once the wires have been connected to the terminal.
		 WARNING: use a double insulated cable and secure it using the supplied cable clamps
		The courtesy light output settings can be modified by selecting AP \rightarrow US or AP \rightarrow LU or AP \rightarrow LG .

Output	Value Accessories	Description
AUX	SOFA1-SOFA2 GOPAV LAN4S LAB9 BIXLR12 BIXLR22 GOL868R4	The control panel has a housing for plug-in control and safety cards. The action of the control card can be selected by selecting BC → AM . If slot-in radio boards are used, remove the RDX module. The display will show RV . WARNING: the plug-in cards must be inserted and removed with the power supply disconnected.
RDX 	ZENRS ZENPRS	The control panel is fitted with a housing for factory-set ZENRS (433.92 MHz) radio receiver type modules. Can be replaced with a ZENPRS (868.35 MHz) radio receiver type module. Operating is selected by selecting BC → RM . If slot-in radio boards are used, remove the RDX module. The display will show RV . WARNING: the modules must be inserted and removed with the power supply disconnected.
		Mains power supply, motor, release microswitch and automation wiring connection (factory settings)
	USB	The control panel has a USB input for connecting a USB memory stick to update the FW or download diagnostic data. It can also be connected to a PC for updates to the firmware file which can be downloaded from the website www.ditecentrematic.com using AMIGO software by way of a USB Standard-A plug to Micro -B plug cable.  For further information refer to the NES100USB kit manual.  WARNING: disconnect the USB card and/or the cable from the USB input only when you have set AP → EJ → NO . The display will show UJ .
COM 	BIXMR2	COM - This allows the functioning configurations to be saved using the function SF → SV . The saved configurations can be recalled using the function SF → RC . COM - The storage module allows the remote controls to be stored. If the control panel is replaced, the storage module being used can be inserted in the new control panel. WARNING: the storage module must be inserted and removed with the power supply disconnected.

Output	Value Accessories	Description	
		DIA - Connection of automation diagnostic LED.	
			OFF No power supply.
			1 flash every 5s Mains power supply present, but gate stopped and waiting for commands. Any external faults are not detected by the diagnostic LEDs.
			flashing in sync with LAMPH Mains power supply present, normal operation. flashing LED in sync with output +LP- (LAMPH)
			1 flash every 10s No mains power supply (battery-powered operation).
			steady on Request for maintenance (V0 alarm)
			steady on Release door open
	SBU 2x12V 2Ah	BAT - Battery-powered operation. The batteries are kept charged when the power supply is on. If the power supply is off, the panel is powered by the batteries until the power is re-establish or until the battery voltage drops below the safety threshold. The panel turns off in the last case. WARNING: the batteries must always be connected to the control panel for charging. Periodically check the efficiency of the batteries. NOTE: the operating temperature of the rechargeable batteries is from +5°C to +40°C. For advanced control of battery-powered operation, refer to the menu EM .	
			NES100FCM LSW - Magnetic limit switch kit (optional on Ditec NES300 and NES400).

6. Selections

Jumper	Description	OFF	ON
JR1	Display mode selection.	Display mode. Only the values and parameters present can be displayed.	Maintenance mode. Only the values and parameters present can be displayed and modified. Going into maintenance mode is indicated by the permanent switching on of the right-hand point on the display.

7. Adjustments



NOTE: pressure on the keys can be quick (less than 2 s) or prolonged (longer than 2 s). Unless specified otherwise, quick pressure is intended.
To confirm the setting of a parameter, prolonged pressure is necessary.

7.1 Switching the display on and off

The procedure to switch on the display is as follows:

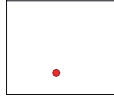

- press the ENTER key



- the display functioning check starts



- the first level menu is displayed



The procedure to switch off the display is as follows:

- press the ESC key



NOTE: the display switches off automatically after 60 s of inactivity.

7.2 Key combinations

- Simultaneous pressing of the keys \uparrow and ENTER performs an opening command.



- Simultaneous pressing of the keys \downarrow and ENTER performs a closing command.



- Simultaneous pressing of the keys \uparrow and \downarrow performs a POWER RESET command. (interruption of the power supply and restart of the automation).

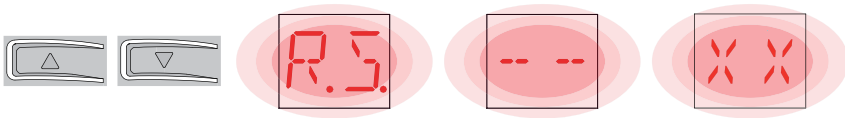

- Hold down the UP \uparrow or DOWN \downarrow key to begin fast menu scrolling.
- In some menus, the parameter unit of measurement can be displayed by pressing the ENTER key once the value has been displayed (in the example, 50 cm).

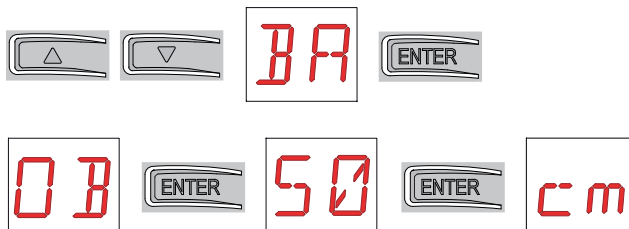

7.3 Main menu

- using keys ↑ and ↓ select the desired function



- press the ENTER key to confirm



After confirming the selection, you access the second level menu.

Display	Description
AT	AT - Automatic Configurations. The menu allows you to manage the automatic configurations of the control panel.
BC	BC - Basic Configurations. The menu allows you to display and modify the main settings of the control panel.
BA	BA - Basic Adjustments. The menu allows you to display and modify the main adjustments of the control panel. NOTE: some settings require at least three operations before they are set correctly.
RO	RO - Radio Operations. The menu allows you to manage the radio operations of the control panel.
SF	SF - Special Functions. The menu allows you to set the password and manage the special functions in the control panel.
CC	CC - Cycles Counter. The menu allows you to display the number of operations carried out by the automation and manage the maintenance interventions.
EM	EM - Energy Management. The menu allows you to display and modify the energy saving settings and adjustments.
AP	AP - Advanced Parameters. The menu allows you to display and modify the advanced settings and adjustments of the control panel. NOTE: some settings require at least three operations before they are set correctly.



WARNING: depending on the type of automation and control panel, some menus may not be available.

7.4 Second level menu AT (Automatic Configurations)

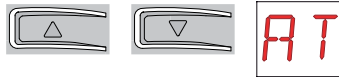

- using keys ↑ and ↓ select the desired function



- press the ENTER key to confirm

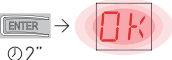

Display	Description
	RT - Opening to right.
	LF - Opening to left.
	H0 - Predefined setting, residential use 0. This selection loads predefined values for certain standard parameters: AC - enabling of automatic closing : 1-2 C5 - step-by-step/opening command operation : step-by-step RM - remote control operation : step-by-step AM - AUX plug-in card operation : step-by-step SS - Selection of automation status at start-up : open
	H1 - Predefined setting, residential use 1. This selection loads predefined values for certain standard parameters: AC - enabling of automatic closing : enabled TC - setting of automatic closing time : 1 minute C5 - step-by-step/opening command operation : step-by-step RM - remote control operation : step-by-step AM - AUX plug-in card operation : step-by-step SS - Selection of automation status at start-up : closed
	C0 - Predefined setting, condominium use 0. This selection loads predefined values for certain standard parameters: AC - enabling of automatic closing : enabled TC - setting of automatic closing time : 1 minute C5 - step-by-step/opening command operation : opening RM - remote control operation : opening AM - AUX plug-in card operation : opening SS - Selection of automation status at start-up : closed
	RD - Resetting of general settings (SETTINGS RESET).  ∅2"

Display	Description
	<p data-bbox="296 119 716 151">AA - Activating advanced parameters menu.</p> <div data-bbox="296 167 677 263">  </div> <p data-bbox="296 343 812 422">After activation you can scroll through the third level menus. The third level menus are activated for 30 min.</p>
	



Depending on the type of automation and control panel, some menus may not be available.

7.5 Second level menu - BC (Basic Configurations)

- using keys ↑ and ↓ select the desired function

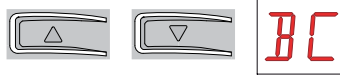

- press the ENTER key to confirm



BC - Basic configurations	Display	Description		
	AC	AC - Enabling of automatic closing. ON - Enabled 1-2 - Dependent on input 1-2	ON	<u>1-2</u>
	SS	SS - Selection of automation status at start. OP - Open CL - Closed Indicates how the control panel considers the automation at the time of switch-on, or after a POWER RESET command.	OP	<u>CL</u>
	SO	SO - Enabling of reversal safety contact functioning. ON - Enabled OF - Disabled When enabled (ON) with the automation idle, if the contact 1-8 is open, all operations are prevented. When disabled (OF) with the automation idle, if the contact 1-8 is open, opening operations are permitted.	<u>ON</u>	OF
	NI	NI - Enabling of NIO electronic anti-freeze system. ON - Enabled OF - Disabled When enabled (ON) it maintains motor efficiency even at low ambient temperatures, increases the starting time ST to the maximum value and reduces the acceleration time TA to the minimum value. NOTE: for correct operation, the control panel must be exposed to the same ambient temperature as the motors. The intervention temperature for NIO can be set by selecting AP → TN .	ON	<u>OF</u>



WARNING: depending on the type of automation and control panel, some menus may not be available.

7.5.1 Additional BC level parameters that can be configured (available with **AT** → **AA** enabled)

BC - Basic configurations	Display	Description		
	OL	OL - Automation open indicator light mode ON - Steady on OF - Flashing	ON	OF
	CS	C5 - Step-by-step/opening command operation. 1-5 - Step-by-step 1-3 - Opening	1-5	1-3
	RM	RM - Radio receiver operation. 1-5 - Step-by-step 1-3 - Opening	1-5	1-3
	AM	AM - AUX plug-in control card operation. 1-5 - Step-by-step 1-3 - Opening	1-5	1-3
	PP	PP - Setting step-by-step sequence from command 1-5. ON - Opening-Stop-Closing-Stop-Opening OF - Opening-Stop-Closing-Opening	ON	OF
	SS	S5 - Duration of STOP in step-by-step sequence from command 1-5. ON - Permanent OF - Temporary	ON	OF
	OD	OD - Selecting opening direction. LF - Opening to left. RT - Opening to right. The opening direction is intended by viewing the automation from the side being examined. NOTE: Modification of status from RT to LF and vice-versa performs an automatic RESET of the card.	LF	RT

7.6 Second level menu - BA (Basic Adjustment)

- using keys ↑ and ↓ select the desired function

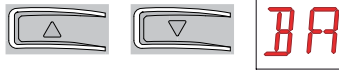

- press the ENTER key to confirm



BA - Basic adjustment	Display	Description		
	MT	MT - Display of type of automation. N3 - Motor with 300kg capacity N4 - Motor with 400kg capacity N6 - Motor with 600kg capacity N1 - Motor with 1000kg capacity NOTE: this parameter is DISPLAY only.	N3	N4
			N6	N1
	TC	TC - Setting of automatic closing time. [s] It is set with different intervals of sensitivity. <ul style="list-style-type: none"> from 0" to 59" with intervals of 1 second; from 1' to 2' with intervals of 10 seconds. 	00'59"	
			1' 21"	
			1'00"	
RP	RP - Adjustment of partial opening measurement. [%] Adjusts the percentage of operation in relation to the total opening of the automation. <ul style="list-style-type: none"> 10 - Minimum 99 - Maximum 	10'99"		
		30		
TP	TP - Setting of automatic closing time after partial opening. [s] It is set with different intervals of sensitivity. <ul style="list-style-type: none"> from 0" to 59" with intervals of 1 second; from 1' to 2' with intervals of 10 seconds. 	00'59"		
		1' 21"		
		00'30"		
VA	VA - Setting of opening speed. [cm/s] NOTE: <ul style="list-style-type: none"> 19 - Maximum with MT → N1 24 - Maximum with MT → N6 25 - Maximum with MT → N3 or N4 	10'25"		
		15		
VC	VC - Setting of closing speed. [cm/s] NOTE: <ul style="list-style-type: none"> 19 - Maximum with MT → N1 24 - Maximum with MT → N6 25 - Maximum with MT → N3 or N4 	10'25"		
		15		

BA - Basic adjustment	Display	Description
	R 2	<p>R2 - Adjustment of thrust on obstacles and current during opening [%]</p> <p>The control panel is equipped with a safety device that stops movement if an obstacle is detected during an opening operation with disengagement of 10cm.</p> <p>00 - Minimum thrust 99 - Maximum thrust</p>
R 1	<p>R1 - Adjustment of thrust on obstacles and current during closing [%]</p> <p>The control panel is fitted with a safety device which stops or reverses movement when an obstacle is detected during a closing operation.</p> <p>00 - Minimum thrust 99 - Maximum thrust</p>	



WARNING: depending on the type of automation and control panel, some menus may not be available.



NOTE: make adjustments gradually and only after performing at least three complete operations to allow the control panel to be set correctly and detect any friction during operations.

7.6.1 Additional BA level parameters that can be configured (available with **AT** → **AA** enabled)

Display	Description	
DT	DT - Adjustment of obstacle recognition time. [s/100] 10 - Minimum 60 - Maximum NOTE: the parameter is adjusted in hundredths of a second.	10 60 40
MP	MP - Start at maximum power ON - During start-up it increases the thrust on obstacles to maximum. OFF - During start-up the thrust on obstacles is that adjusted by R 1 - R2	ON OF
ST	ST - Adjustment of start time. [s] 0.5 - Minimum 3.0 - Maximum	0.5 3.0 2.0
TA	TA - Adjustment of acceleration time. [s] 0.5 - Minimum (start speed is 75% of V A - V C) 2.0 - Maximum	0.5 2.0 2.0
TD	TD - Adjustment of deceleration time. [%] 10 - Minimum 99 - Maximum	10 99 75
OB	OB - Adjustment of deceleration distance during opening. [cm] Indicates the distance from the end of the opening stroke where the deceleration ramp begins. 05 - Minimum 99 - Maximum NOTE: reduce the deceleration space if there is a series of quick vibrations (chattering) in heavy gates installed with a slight incline.	05 99 40
CB	CB - Adjustment of deceleration distance during closing. [cm] Indicates the distance from the end of the closing stroke where the deceleration ramp begins. 05 - Minimum 99 - Maximum NOTE: reduce the deceleration space if there is a series of quick vibrations (chattering) in heavy gates installed with a slight incline.	05 99 40
PO	PO - Adjustment of approach speed during opening. [cm/s] Indicates the speed from the end of the deceleration ramp to the end of the stroke. 02 - Minimum 10 - Maximum NOTE: gradually increase the approach speed if there is a series of quick vibrations (chattering) in heavy gates installed with a slight incline.	02 10 03

BA - Basic adjustment

Display	Description	
PC	<p>PC - Adjustment of approach speed during closing. [cm/s] Indicates the speed from the end of the deceleration ramp to the end of the stroke. 02 - Minimum 10 - Maximum NOTE: gradually increase the approach speed if there is a series of quick vibrations (chattering) in heavy gates installed with a slight incline.</p>	<p>02 10 03</p>
00	<p>00 - Obstacle detection limit during opening [cm] Indicates the distance from the end of the opening stroke after which each obstacle is considered a stop. 05 - Minimum 99 - Maximum NOTE: This parameter is only active if AP → FA → NO</p>	<p>05 99 40</p>
0C	<p>0C - Obstacle detection limit during closing [cm] Indicates the distance from the end of the closing stroke after which each obstacle is considered a stop. 05 - Minimum 99 - Maximum NOTE: This parameter is only active if AP → FC → NO</p>	<p>05 99 40</p>



NOTE: make adjustments gradually and only after performing at least three complete operations to allow the control panel to be set correctly and detect any friction during operations.

7.7 Second level menu - RO (Radio Operations)

- using keys ↑ and ↓ select the desired function



- press the ENTER key to confirm



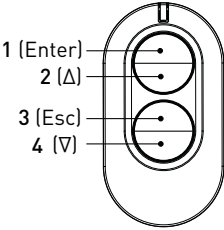

Display	Description	
<p style="writing-mode: vertical-rl; transform: rotate(180deg);">R0 - Radio operations</p> <p style="font-size: 2em; color: red;">SR</p>	<p>SR - Remote control storage.</p> <p>You can directly access the Remote control storage menu even with the display turned off, but only with the Display visualisation mode option set to 00 or 03:</p> <ul style="list-style-type: none"> - for transmitting a remote control not present in the memory; - for transmitting an unstored channel of a remote control already present in the memory. <p>WARNING: if the display NO flashes, the remote control may have already been stored.</p>	
<p style="font-size: 2em; color: red;">TX</p>	<p>TX - Visualisation of counter showing remote controls stored</p> <p>→ 16 remote controls (example)</p>	
<p style="font-size: 2em; color: red;">MU</p>	<p>MU - Indication of maximum number of remote controls that can be stored in the integrated memory.</p> <p>You can store a maximum of 100 or 200 remote control codes.</p> <p>20 - 200 storable remote controls 10 - 100 storable remote controls</p>	<p style="font-size: 2em; color: red;">20</p> <p style="font-size: 2em; color: red; text-decoration: underline;">10</p>

Display	Description	
<p style="color: red; font-size: 2em; font-weight: bold;">RK</p>	<p>RK - Menu navigation using remote control keyboard. ON - Enabled OF - Disabled</p> <p>We recommend using a NES100TXT (433,92MHz) or NES200TXT (868,35MHz) remote control.</p> <p>With the display turned off, quickly type in the sequence of keys ③ ③ ② ④ ① from the stored remote control you want to use. Make sure all the CH keys are stored.</p> <p>WARNING: during navigation with a remote control keyboard ALL the stored remote controls are inactive.</p> <div style="text-align: center;">  <p>1 (Enter) 2 (Δ) 3 (Esc) 4 (∇)</p> </div> <p>To aid viewing and adjustment (avoiding the need to continuously press the remote control), press the UP ↑ or DOWN ↓ key once to begin slowly scrolling through the parameters. This scrolling movement is faster if the UP ↑ or DOWN ↓ key is pressed twice. To stop the scrolling, press ENTER. To confirm your choice of parameter, press ENTER again. To test any new setting, switch off the display and issue an opening command using key ③. Navigation using a remote control keyboard is automatically disabled after 4 minutes of inactivity or by setting RK → OF.</p>	<p style="color: red; font-size: 2em; font-weight: bold;">ON OF</p> <p style="color: green; font-size: 2em; font-weight: bold; text-decoration: underline;">OF</p>



WARNING: depending on the type of automation and control panel, some menus may not be available.

7.7.1 Additional RO level parameters that can be configured (available with **AT** → **AA** enabled)

RO - Radio operations	Display	Description		
	<p>C1, C2, C3, C4 - Selection of CH1, CH2, CH3, CH4 function of stored remote control.</p> <p>NO - No setting selected</p> <p>1-3 - Opening command</p> <p>1-4 - Closing command</p> <p>1-5 - Step-by-step command</p> <p>P3 - Partial opening command</p> <p>LG - Command to switch on/off the courtesy light</p> <p>1-9 - STOP command</p> <p>If only one (any) CH key of the remote control is stored, the opening or step-by-step command is carried out.</p> <p>WARNING: options 1-3 (opening) and 1-5 (step-by-step) are available as an alternative and depend on the selection BC → RM.</p> <p>If 2-4 CH keys of a single remote control are stored, the factory-set functions matched with the CH keys are as follows:</p> <ul style="list-style-type: none"> • CH1 = opening/step-by-step command; • CH2 = partial opening command; • CH3 = command to switch on/off the courtesy light • CH4 = STOP command. 	<p>NO</p> <p>1-5</p> <p>P3</p> <p>LG</p>	<p>1-3</p> <p>1-4</p> <p>1-9</p>	
	<p>ER - Cancelling a single remote control.</p> 			
	<p>EA - Cancelling an entire memory.</p> 			
	<p>EC - Cancelling a single code. (FOR FUTURE USE)</p>			
	<p>RE - Setting memory opening from remote control.</p> <p>OF - Disabled</p> <p>ON - Enabled. When enabled (ON), the remote programming is activated.</p> <p>To store new remote controls without using the control panel, press the PRG key of an already stored GOL4 remote control for 5 seconds until the LED comes on (within the range of the receiver) and press any one of the CH keys on the new remote control.</p> <p>NOTE: make sure you do not accidentally memorise unwanted remote controls.</p>	<p>ON</p> <p>OF</p>		
	<p>EP - Setting the coded area messages</p> <p>If the possibility to receive coded messages is enabled, the control panel will be compatible with remote controls of the "ENCRYPTED" type.</p>	<p>ON</p> <p>OF</p>		
	<p>MS - Backward compatibility setting with older generation GOL4 remote controls.</p> <p>NOTE: Firmware version 2.0.7 or later</p> <p>OF - Compatibility with old generation GOL4 and new ZEN remote controls.</p> <p>ON - Compatibility with ZEN series remote controls.</p> <p>NOTE: MS= ON is recommended if only ZEN series remote controls are used on the system.</p>	<p>ON</p> <p>OF</p>		

7.8 Second level menu - SF (Special Functions)

- using keys \uparrow and \downarrow select the desired function

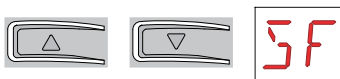









- press the ENTER key to confirm

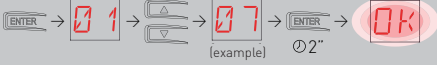

Display	Description
CU	CU - Displaying the control panel firmware version.
SV	SV - Saving user configuration on control panel storage module. <p>By selecting RO \rightarrow MU \rightarrow 10 you can save up to 2 personalised configurations in memory positions U 1 and U2 only with the storage module present on the control panel.</p> <p>WARNING: if more than 100 remote control codes are stored on the control panel storage module, you cannot save any user configuration.</p> <p>WARNING: if the display NO flashes, the storage module may not be present.</p>
RC	RC - Loading configuration. <p>You can upload the user configurations previously saved U 1 and U2 on the control panel storage module, or upload the predefined settings available in memory positions 0 1, 02, 03 and 04.</p> <p>01 - parameter setting for passive edge on closing edge and stopping limit switch.</p> <p>02 - parameter setting for passive edges on both edges and stopping limit switch.</p> <p>03 - FUTURE USE</p> <p>04 - FUTURE USE</p>
RL	RL - Loading the last configuration set. <p>The control panel automatically saves the last configuration set, and keeps it memorised in the storage module. In the event of a fault or the replacement of the control panel, the last configuration of the automation can be restored by inserting the storage module and loading the last configuration set.</p>

SF - Special Functions

7.8.1 Additional SF level parameters that can be configured (available with **AT** → **AA** enabled)

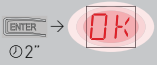
Display	Description
SP	<p>SP - Setting the password.</p>  <p>(example) 02"</p> <p>NOTE: this can only be selected when the password is not set. Setting the password prevents unauthorised personnel from accessing selections and adjustments. You can delete the set password by selecting the sequence JR1=ON, JR1=OFF, JR1=ON.</p>
IP	<p>IP - Inserting the password.</p>  <p>(example) 02"</p> <p>NOTE: this can only be selected when the password is set. When the password is not inserted, you can access the display mode regardless of the selection made with JR1. When the password is inserted, you can access in maintenance mode.</p>
EU	<p>EU - Cancellation of user configurations and last configuration set in the storage module.</p>  <p>02" 02"</p>
AL	<p>AL - Alarm counter</p> <p>Used to view, in sequence, the counters of alarms that have been triggered at least once (alarm code + number of times triggered). With  and , you can scroll through all the counters and see all the alarms recorded.</p>
AH	<p>AH - Alarm log</p> <p>Used to view, in sequence, alarms that have been triggered (maximum 20). With  and , you can scroll through the entire alarm log. The display shows the alarm number and code, alternated. The highest number corresponds to the most recent alarm and the lowest number (0) corresponds to the oldest alarm.</p>
AR	<p>AR - Alarm reset</p> <p>Resets all the alarms in the memory (counters and log).</p>  <p>02"</p> <p>NOTE: when the installation has been completed, you are advised to delete the alarms in order to facilitate future checks.</p>
AE	<p>AE - Writing of alarms on NES100USB</p> <p>Creates a text file on the NES100USB memory, containing some information about the control panel: the firmware version, operation counters, hour counters, configuration parameters, alarms.</p>  <p>02"</p> <p>NOTE: the alarm counters and alarm log are associated with the number of the operation that was in progress when they were triggered.</p>



WARNING: depending on the type of automation and control panel, some menus may not be available.

7.9 Second level menu - CC (Cycles Counter)

- using keys ↑ and ↓ select the desired function

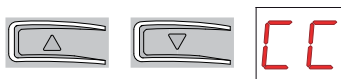

- press the ENTER key to confirm



Display	Description
CV	CV - Display of total operations counter. → → → → 182 operations (example)
CP	CP - Display of partial operations counter. → → → → 716 operations (example)
CH	CH - Display of power supply hour counter. → → → → 256 hours of power (example)



WARNING: depending on the type of automation and control panel, some menus may not be available.

7.10 Second level menu - EM (Energy Management)

- using keys ↑ and ↓ select the desired function



- press the ENTER key to confirm









Display	Description		
PV	PV - Solar panel power supply (panels not supplied) ON - Enabled OF - Disabled	ON	OF
ES	<p>ES - Accessory power supply disconnection with automation stopped or in stand-by "Energy Saving" mode (RECOMMENDED FOR SOLAR PANEL SYSTEMS - not supplied).</p> <p>ON - Enabled (the LEDs are OFF, the red dot on the right flashes every 5 s on the display, the flashing light and the courtesy light are not operated).</p> <p>OF - Disabled</p> <p>The power supply disconnection mode is activated after 10 s with the gate closed or when the gate is closed and automatic closing is not enabled or when a 1-9 - STOP command intervenes.</p> <p>The automation resumes normal operation after a command received from the radio card (ZENRS-ZENPRS) or after activation of a contact (for example, key selector switch) connected between G3-G1.</p> <p>WARNING:</p> <ul style="list-style-type: none"> - The GOPAV safety devices are not compatible with this selection. Only SOF safety devices can be used. - If ES is enabled, parallel or interlocked systems cannot be used. - With ES enabled, some signals like those for the maintenance alarm and flat batteries are not active. - The USB output is not active with ES enabled. - The operating hours CH counter is not active. 	ON	OF

EM - Energy management



WARNING: depending on the type of automation and control panel, some menus may not be available.

7.10.1 Additional EM level parameters that can be configured (available with **AT** → **AA** enabled)

EM - Energy management	Display	Description		
		<p>LL - Voltage threshold for indicating that batteries are almost flat (V) 17 - Minimum 24 - Maximum</p> <p>NOTE: it is set with an interval of sensitivity of 0.5 V shown when the decimal point on the right lights up.</p>		
	<p>LB - Indication that batteries are almost flat</p> <p>00 - Indication on display (alarm message B0).</p> <p>01 - Indication on flashing light (with the automation stopped, it flashes 4 times keep happening every hour) and display (alarm message B0).</p> <p>02 - Indication on gate open indicator light (with the automation closed, it flashes 4 times keep happening every hour) and display (alarm message B0).</p>	 		

7.11 Second level menu - AP (Advanced Parameters)



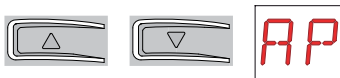



- using keys ↑ and ↓ select the desired function



- press the ENTER key to confirm



AP - Advanced parameters	Display	Description		
	FA	FA - Selection of opening limit switch mode.		
		NO - None	NO	SX
		SX - Stop limit switch (after activation the door wing stops its movement)		
		PX - Proximity limit switch (after activation the door wing continues as far as the end stop and any obstacle is considered a stop)	PX	
	----- (with standard limit switches)			
FC	FC - Selection of closing limit switch mode.			
	NO - None	NO	SX	
	SX - Stop limit switch (after activation the door wing stops its movement)			
	PX - Proximity limit switch (after activation the door wing continues as far as the end stop and any obstacle is considered a stop)	PX		
	----- (with standard limit switches)			
D6	D6 - Selection of device connected to terminals 1-6.			
	NO - None	NO	SE	
	SE - Safety edge (if contact 1-6 opens, after stopping, there is a disengagement of 10cm)			
	S41 - Safety edge with safety test (if contact 1-6 opens, after stopping, there is a disengagement of 10cm)	S41	PH	
	PH - Photocells		—	
	P41 - Photocells with safety test	P41		
D8	D8 - Selection of device connected to terminals 1-8.			
	NO - None	NO	SE	
	SE - Safety edge			
	S41 - Safety edge with safety test	S41	PH	
	PH - Photocells		—	
	P41 - Photocells with safety test	P41		

Display	Description		
	DS - Setting of display visualisation mode.		
	00 - No display		
	01 - Commands and safety devices with radio test (see paragraph 8.2). Display of count down to automatic closing.		
	02 - Automation status (see paragraph 8.1) 03 - Commands and safety devices (see paragraph 8.2)		
NOTE: setting  1 displays the receipt of a radio transmission for range tests.			



WARNING: depending on the type of automation and control panel, some menus may not be available.



NOTE: make adjustments gradually and only after performing at least three complete operations to allow the control panel to be set correctly and detect any friction during operations.

7.11.1 Additional AP level parameters that can be configured (available with **AT** → **AA** enabled)

Display	Description	
ED	<p>ED - Enabling of diagnostics Enables periodic saving of data via serial for diagnostic use.</p> <p>NO - Disabled 01 - Checking virtual encoder (DO NOT USE) 02 - Alarm log</p>	<p>NO 0 1 02</p>
US	<p>US - Type of C-NO contact use 0F - Contact always open 01 - Courtesy light (LUoLG) 02 - LAMP flashing (230V~) 03 - Gate closed 04 - Gate open 05 - Gate moving 06 - Gate opening 07 - Gate closing ON - Contact always closed</p>	<p>0F 0 1 02 0 3 04 0 5 06 0 7 ON</p>
LU	<p>LU - Setting switch-on time for courtesy light (s). To enable the parameter, set AP → US → 0 1. It is set with different intervals of sensitivity.</p> <p>NO - Disabled - from 01" to 59" with intervals of 1 second; - from 1' to 2' with intervals of 10 seconds; - from 2' to 3' with intervals of 1 minute; ON - Permanently ON, switched off with remote control</p> <p>NOTE: The courtesy light switches on at the start of each operation.</p>	<p>NO 0 1 5 9 1' 2' 2' 3' ON</p>
LG	<p>LG - Setting switch-on time for courtesy light controlled independently. [s] To enable the parameter, set AP → US → 0 1. It is set with different intervals of sensitivity.</p> <p>NO - Disabled - from 01" to 59" with intervals of 1 second; - from 1' to 2' with intervals of 10 seconds; - from 2' to 3' with intervals of 1 minute; ON - Switched on and off with remote control.</p> <p>NOTE: The switching on of the light does not depend on the start of an operation, but can be commanded separately using the special remote control key.</p>	<p>NO 0 1 5 9 1' 2' 2' 3' ON</p>

AP - Advanced Parameters

Display	Description		
PA	<p>PA - Automation parallel (see examples of applications) Sets the type of automation parallel</p> <p>01 - Simultaneous automations 02 - Interlocked one-way or two-way transit automations without presence detection 03 - Interlocked one-way transit automations with presence detection</p>	0102 <u>01</u>	03
G 1	<p>G1 - Setting the G1 input mode NO - Absent 1-3 - Opening 1-5 - Step-by-step 1-6 - Safety stop 1-8 - Input 1-8 (safety reopening) depending on setting AP → TS SY - Synchronism input</p>	NO1-3 <u>1-3</u>	1-5 1-6 1-8 SY
PG	<p>PG - Enabling interlocked automation opening control request (see examples of applications). ON - Enabled OF - Disabled When enabled (ON), it requests the automation 1 opening command if automation 2 is engaged in completing the operation.</p>	ON	<u>OF</u>
TO	<p>TO - Motor 2 delay time (s) (see examples of applications). This adjusts the opening delay time of the second interlocked automation. 00 - Minimum 30 - Maximum</p>	00	30 03
PT	<p>PT - Fixed partial opening. ON - Enabled. OF - Disabled If ON, a partial opening command given on the partial opening position is ignored. With contact 1-20 closed (for example with the timer or manual selector), the gate will partially open and if it is then opened completely (command 1-3) and then reclosed (with automatic closing as well), it will stop at the partial opening position.</p>	ON	<u>OF</u>
DO	<p>DO - Setting of disengagement on stop during opening. [mm] 00 - Minimum 10 - Maximum NOTE: Not active if FA → SX</p>	00	10 02
DC	<p>DC - Setting of disengagement on stop during closing. [mm] 00 - Minimum 10 - Maximum NOTE: Not active if FC → SX</p>	00	10 02

AP - Advanced Parameters

Display	Description	
OT	OT - Selection of type of obstacle. 00 - Overcurrent or door stopped 01 - Overcurrent 02 - Door stopped	
CR	CR - Correction to calculated speed. [mm/s] DO NOT USE (diagnostic purposes only)	
R9	R9 - Enabling automatic closing after command 1-9 (STOP) from terminal board. 0F - Disabled. 0N - Enabled. 00 - None. Disables safety device 1-9.	
SM	SM - Selection of operating mode of device connected to terminals 1-6. 00 - During the operation, the opening of the safety contact stops movement (with disengagement if 06 → SE / S4I). 01 - During the operation, the opening of the safety contact stops movement (with disengagement if 06 → SE / S4I). When the contact closes again, the interrupted operation continues. 02 - During the operation, the opening of the safety contact stops movement (with disengagement if 06 → SE / S4I). When the contact closes again, an opening operation is performed. 03 - During the opening operation, the opening of the safety contact stops movement (with disengagement if 06 → SE / S4I). When the contact closes again, the interrupted opening operation is resumed. During the closing operation, the safety device is ignored. 04 - During the closing operation, the opening of the safety contact reverses the movement. During the opening operation, the safety device is ignored. 05 - During the closing operation, the opening of the safety contact stops and reverses the movement. During the opening operation, opening of the safety contact stops movement (with disengagement if 06 → SE / S4I).	
TN	TN - Setting of intervention temperature for NIO anti-freeze system. [°C] Adjustment of the working temperature of the control panel. The value does not refer to ambient temperature.	
TB	TB - Display of working temperature of control panel. DO NOT USE	
WO	WO - Setting of pre-flashing time on opening. [s] Adjustment of the lead time for the switch-on of the flashing light, in relation to the start of the opening operation from a voluntary command. 00 - Minimum 05 - Maximum	

AP - Advanced Parameters	Display	Description	
	WC	WC - Setting of pre-flashing time on closing. [s] Adjustment of the lead time for the switch-on of the flashing light, in relation to the start of the closing operation from a voluntary command. 00 - Minimum 05 - Maximum	0005
	TS	TS - Setting of renewal of automatic closing time after safety device release. [%] 00 - Minimum 99 - Maximum	0099
	VR	VR - Setting of learning speed. [cm/s]	0510

8. Display visualisation mode



WARNING: depending on the type of automation and control panel, some menus may not be available.









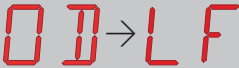

8.1 Display of automation status



The automation status display mode is only visible with Display visualisation mode set to 02.

AP → 05 → 02

Display	Description
00 → RT	
	Automation closed.
	Automation closed. Release door open.
	Automation open.
	Automation open. Release door open.
	Automation stopped in intermediate position.
	Automation stopped in intermediate position. Release door open.
	Automation closing.
	Automation that slows down during closing.
	Automation opening.
	Automation that slows down during opening.

Display	Description
	
	Automation closed.
	Automation closed. Release door open.
	Automation open.
	Automation open. Release door open.
	Automation stopped in intermediate position.
	Automation stopped in intermediate position. Release door open.
	Automation closing.
	Automation that slows down during closing.
	Automation opening.
	Automation that slows down during opening.

















8.2 Display of safety devices and commands







i The safety and command display mode is only visible with Display visualisation mode set at 01 or 03.

AP → DS → 01

AP → DS → 03

Display	Description
1-2	1-2 - Automatic closing command.
1-3	1-3 - Opening command.
1-4	1-4 - Closing command.
1-5	1-5 - Step-by-step command.
1-6	1-6 - Safety device with opening and closing stop.
1-8	1-8 - Safety with closing reversal.
1-9	1-9 - STOP command
P3	P3 - Partial opening command.
3P	3P - Opening command with operator present.
4P	4P - Closing command with operator present.
RX	RX - Radio reception (of any memorised key of a transmitter present in the memory).
NX	NX - Radio reception (of any non-memorised key).

	EX - Rolling-code radio reception out of sequence
	EP - Radio reception not complying with the parameter configuration <i>RQ</i> → <i>EP</i>
	CX - Receipt of command from AUX card.
	F1 - Closing limit switch
	F2 - Opening limit switch
	O1 - Detection of an obstacle during closing
	O2 - Detection of an obstacle during opening
	O0 - Reaching of obstacle detection limit during opening
	OC - Reaching of obstacle detection limit during closing
	S1 - Detection of stop during closing
	S2 - Detection of stop during opening
	SW - Release door open. When the release door is closed, the control panel performs a RESET (alarm )
	RV - Enabling/disabling of built-in radio receiver via RDX.
	MQ - Learning operation of mechanical end stops in progress.
	HT - Heating of the motors (NIO function) in progress.

	JR1 - Variation of the JR1 jumper status.
	G1 - General Purpose 1
	PC - Recognition of connected HOST (Personal Computer).
	UB - Recognition of connected USB memory stick
	UD - Disconnection of cable and USB memory stick
	ES - Switch to Energy Saving mode.
	AO - Interlocked automation opening control request.











8.3 Display of alarms and faults



Alarms and faults can be displayed with any display selection. The signalling of alarm messages takes priority over all other displays.

Type of alarm	Display	Description	Operation	LED
Mechanical alarm		M0 - Selected motor not suitable.	Set correct motor wiring.	
		M3 - Automation blocked (open/closed)	Check the mechanical parts	
		M4 - Motor short circuit	Check the motor is correctly connected. Check the motor is working properly.	
		M8 - Gate too long error (>25 m)	Check the rack / chain belt	
		M9 - Gate too short error (< 200 mm)	Manually check that the door wing moves freely.	
		MB - Absence of motor during an operation.	Check connection of motor. Check motor brush contacts. If the problem persists, contact Technical Support.	
		MD - Irregular functioning of motor opening limit switch.	Check connection of the motor opening limit switch.	
		ME - Irregular functioning of motor closing limit switch.	Check connection of the motor closing limit switch.	
		MI - Detection of fifth consecutive obstacle.	Check for the presence of permanent obstacles along the stroke of the automation.	
		ML - Inverted limit switches	Check limit switch connection.	
Power supply operations alarm		R0 - Insertion of a storage module containing over 100 stored remote controls. WARNING: → → 20 is set automatically. The alarm is displayed 3 times only.	To save the system configurations on the storage module, delete any stored remote controls and bring the total to less than 100. Set → → 10.	

Type of alarm	Display	Description	Operation	LED
Radio operations alarm	R3	R3 - Storage module not detected (with RDX inserted).	Insert a working storage module or remove RDX.	
	R5	R5 - Storage module not working (regardless of RDX)	Replace the storage module.	
Accessories alarm	A0	A0 - Failure of test of safety sensor on contact 6.	Check that device SOFA1-A2/GOPAV is working correctly. If the supplementary card is not inserted, check that DB is not set to S41 / P41	-
	A3	A3 - Failure of test of safety sensor on contact 8.	Check that device SOFA1-A2/GOPAV is working correctly. If the supplementary card is not inserted, check that DB is not set to S41 / P41	-
	A7	A7 - Incorrect connection of contact 9 to G3	Check that terminal 1 and 9 are correctly connected.	-
	A9	A9 - Flashing light output short circuit alarm	Check that the flashing light is working properly.	-
	AB	AB - Gate open indicator light shortcircuit alarm	Check that the gate open indicator light is working correctly.	-
Battery	B0	B0 - Battery almost flat	Check battery voltage. Replace battery.	●
Power supply alarm	P0	P0 - No mains voltage.	Check the control panel is powered correctly. Check the line fuse. Check the mains power supply.	●
	P1	P1 - Microswitch voltage too low	Check the control panel is powered correctly.	
Control panel internal alarm	I2	I2 - No communication between parallel automations.	Check G1 (MASTER) - G3 (SLAVE) and G3 (MASTER) - G1 (SLAVE) connections. Reset. If the problem persists, contact Technical Support.	
	I7	I7 - Internal parameter outside limits error	Reset. If the problem persists, replace the control panel.	-
	I8	I8 - Program sequence error	Reset. If the problem persists, replace the control panel.	-

Type of alarm	Display	Description	Operation	LED
Control panel internal alarm		IA - Internal parameter error (EEPROM)	Reset. If the problem persists, replace the control panel.	●
		IB - Internal parameter error (RAM)	Reset. If the problem persists, replace the control panel.	●
		IC - Operation time out error (>5 min or >7 min in acquisition mode)	Manually check that the door wing moves freely. If the problem persists, replace the control panel.	●
		IH - Overcurrent with motor switched off alarm	Reset. If the problem persists, replace the control panel.	●
Control panel internal alarm		IM - Shortcircuited motor MOSFET alarm	Reset. If the problem persists, replace the control panel.	●
		IO - Interrupted power circuit (motor MOSFET open)	Reset. If the problem persists, replace the control panel.	●
		IR- Motor relay malfunctioning	Reset. If the problem persists, replace the control panel.	●
		XX - Firmware reset (SIGNAL ONLY)		
Service		V0 - Request for maintenance intervention	Proceed with the scheduled maintenance intervention.	●
		NO - Operation not permitted	Check that the remote control has not already been stored. Check that the storage module is present.	

9. Start-up



WARNING

The operations related to point 5 are performed without safety devices. The display parameters can only be adjusted when the automation is idle. The automation automatically slows when approaching the end stops or stop limit switches.

At every start-up the control panel receives a RESET and the first operation is performed at reduced speed (automation position acquisition).

- 1- Make a jumper for NC safety contacts.
- 2- Adjust the opening and closing stop limit switches, if any.
NOTE: The limit switches must remain pressed until the operation is completed and placed as shown in the Ditec NEOS installation manual.
- 3- Set the desired opening direction from the **AT** menu.
- 4- Manually move the sliding gate and make sure the entire stroke slides evenly and without friction.
- 5- Switch on and check the automation is operating correctly with the subsequent opening and closing commands (see paragraph 7.2).
Check that the limit switches are activated if used.
- 6- Connect the safety devices **DB** and **DB** → **SY** (removing the relative jumpers) and check they are working correctly.
- 7- To modify the operation and deceleration speed settings, automatic closing times and thrust on obstacles, consult the menus.
- 8- Connect any other accessories and check they are functioning.
WARNING: Ensure that the forces exerted by the door wings are compliant with EN12453-EN12445 regulations.
- 9- If required, store the remote controls using command **RD** → **SR**.
- 10- Once the start-up and check procedures are completed, close the container.



NOTE: in the event of servicing or if the control panel is to be replaced, repeat the start-up procedure.

10. Troubleshooting

Problem	Possible cause	Signal Alarm	Operation	
The automation does not open or close.	No power.	P0	Check power supply cable.	
	Short-circuited accessories		Disconnect all accessories from terminals 0-1 (a voltage of 24V= must be present) and reconnect them one at a time. Contact Technical Service	
	Blown line fuse.	P0	Replace fuse.	
	Safety contacts are open.	I-6 I-8	Check that the safety contacts are closed correctly (NC).	
	Safety contacts not correctly connected or self-controlled safety edge not functioning correctly.	A0 A3 I-6 I-8	Check connections to terminals 6-8 on control panel and connections to the self-controlled safety edge.	
	SAFETY SWITCH release microswitch open.	SW	Check that the hatch is closed correctly and the microswitch makes contact.	
	Photocells activated.	I-6 I-8	Check that the photocells are clean and operating correctly.	
	The automatic closing does not work.			Issue any command. If the problem persists, contact Technical Service
			A7 I-9	Check terminal 9 on the control panel.
	Mechanical fault	M3 M8	Check the rack or transmission chain, and/or the mechanical parts.	
Faulty motor	M4 M8	Check motor connection, if the problem persists, contact Technical Service.		
Faulty control panel	I7 I8 IAB IB IH IM IO IR	Replace the control panel.		

Problem	Possible cause	Signal Alarm /	Operation
The external safety devices are not activated.	Incorrect connections between the photocells and the control panel.		Check that I-6 / I-8 is displayed Connect NC safety contacts together in series and remove any jumpers on the control panel terminal board. Check the AP → J6 and AP → J8 setting
The automation opens/closes briefly and then stops.	There is a presence of friction.	M9 IC MI	Manually check that the automation moves freely and check the R 1/R2 adjustment Contact Technical Service
The remote control has limited range and does not work with the automation moving.	The radio transmission is impeded by metal structures and reinforced concrete walls.		Install the antenna outside. Replace the transmitter batteries.
The remote control does not work	No storage module or incorrect storage module.	R0 R3 R5	Switch the automation off and plug in the correct storage module. Check the correct memorisation of the transmitters on the built-in radio. If there is a fault with the radio receiver that is built into the control panel, the remote control codes can be read by removing the storage module.
The flashing light is not working	Bulb burnt or flashing light wires detached or short-circuited.	A9	Check the bulb and/or wires. Contact Technical Service
The "gate open" indicator light doesn't work	Bulb burnt or wires detached or short-circuited.	A8	Check the bulb and/or wires. Contact Technical Service

11. Examples of sliding gate applications

When the CS12M control panel is used for sliding automation applications, the following connections can be made:

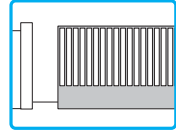

- set the correct opening direction:

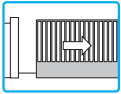

⏮ ⏪ **AT** ⏩ ⏭ **RT** ⏩ x2 s **OK**

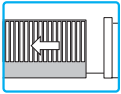

⏮ ⏪ **AT** ⏩ ⏭ **LF** ⏩ x2 s **OK**

Example 1 - Door wing stops against mechanical end stops (standard setting)

Set

⏮ ⏪ **AP** ⏩ ⏭ **FA** ⏩ **NO** ⏩ **OK**

⏮ ⏪ **AP** ⏩ ⏭ **FC** ⏩ **NO** ⏩ **OK**

Example 2 - Door wing stops against limit switches (setting with standard limit switches installed)

Connect the limit switches to the terminal 

Set

⏮ ⏪ **AP** ⏩ ⏭ **FA** ⏩ **SX** ⏩ **OK**

⏮ ⏪ **AP** ⏩ ⏭ **FC** ⏩ **SX** ⏩ **OK**

With these settings, if an obstacle is detected while opening, the door wing stops and performs a disengagement operation whereas during a closing operation, the door wing reopens.

Example 3 - Door wing stops against mechanical end stops and reverses motion if an obstacle is detected

Connect the limit switches to the terminal 

Set

⏮ ⏪ **AP** ⏩ ⏭ **FA** ⏩ **PX** ⏩ **OK**

⏮ ⏪ **AP** ⏩ ⏭ **FC** ⏩ **PX** ⏩ **OK**

In this configuration, the door wing stops against its respective mechanical closing and opening end stop. In the event of obstacle detection before the activation of the proximity limit switch while opening, the door wing stops, performing a disengagement operation; after the proximity limit switch is activated, the door wing stops against the obstacle.

In the event of obstacle detection during closing and before the activation of the proximity limit switch, the door wing reopens; after the proximity limit switch is activated, the door wing stops against the obstacle.

12. Examples of application for parallel automations

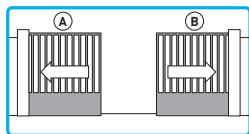

With the parallel connection, the opening, closing, reopening when an obstacle is encountered during closing and flashing of flashing lights are synchronised.

The obstacle during opening and safety devices (safety edges) must be installed each one on its own door and act independently of each other.

Establish which one is the MASTER automation and which one is the SLAVE automation. The MASTER automation could be the one you decide to open partially (1-20 connected).

1. Disconnect connectors 1-G1-G3 from the control panels.
2. Set the following parameters on both automations via the display:

Setting advanced parameters



Setting input mode

AP > G 1 > 5 Y

Setting automation parallel mode

AP > PA > 0 1

Set **BC > SO > OF.**

NOTE: if **SO > ON**, if one door is closed and the other is closing, a command 1-8 causes the movement of the moving door to stop without reopening the closed door.

You are advised **NOT** to change the setting of parameter **AP > SM > 00.**

3. Reconnect connectors 1-G1-G3.
4. Enable automatic closing only on the MASTER automation with **BC > AC > ON**, or with **BC > AC > 1-2** (if you want to use a timer).
5. Set the desired automatic closing time (**BA > TC**) on the MASTER automation high enough to allow the SLAVE automation to fully open.

With these settings the automations will perform the closing operation at the same time as the time set with the MASTER automatic TC expires).

6. Install only one ZENRS radio receiver - ZENPRS on the MASTER automation.

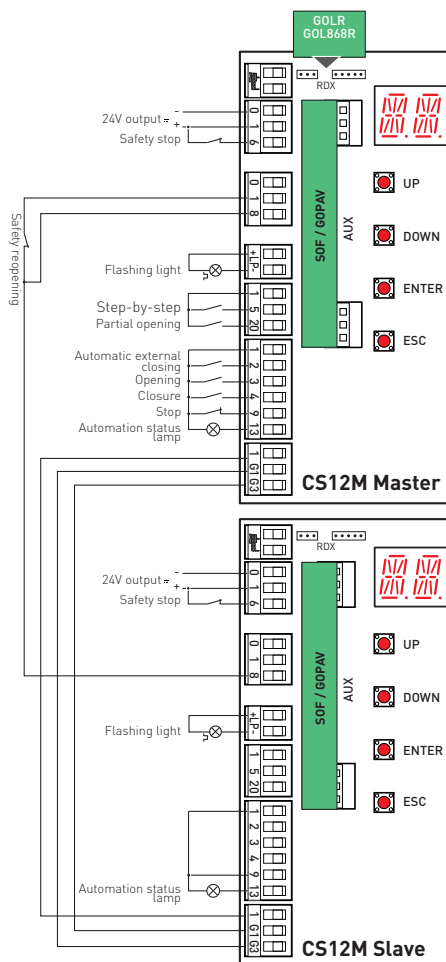

13. Examples of application for interlocked one-way or two-way transit automations without presence detection

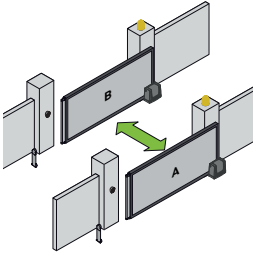

With these settings, command 1-3 starts an opening operation of the automation that it is connected to which will close after the time set with $BA > TC$. Once the delay time set with $AP > TO$ has elapsed, the other automation will open and will close after the time set with $BA > TC$.

Commands 1-5, 1-4 and 1-20 can be used in special cases, for example, to allow very long vehicles to pass through.

Command 1-9 can interrupt the interlock sequence, i.e., cancel the command given to automation B.

Disconnect connectors 1-G1-G3 from the control panels.

1. Set the following parameters on both automations via the display:
Setting advanced parameters



Setting input mode

$AP > G 1 > 5 Y$

Setting automation parallel mode

$AP > PA > 02$

3. Reconnect connectors 1-G1-G3.
4. Set $BC > RM > 1-3$ on both automations.

NOTE: we recommend storing two different keys and not the same transmitter key (example: key 1 opens automation A and key 2 opens automation B).

5. If necessary, enable automatic closing $BC > AC > ON$ on both automations.

6. Set the desired automatic closing time ($BA > TC$) on both automations.

7. Set the delay time $AP > TO$ (from 0 to 30 s) on both automations.

8. The reservation function $BC > PG > ON$ can be enabled on both automations if a vehicle arrives from the same opening direction while another one is still in transit.

A second opening command is stored and executed as soon as the cycle in progress terminates. **NOTE:** we recommend using the reservation function only for one-way transit or two-way transit with limited flow.

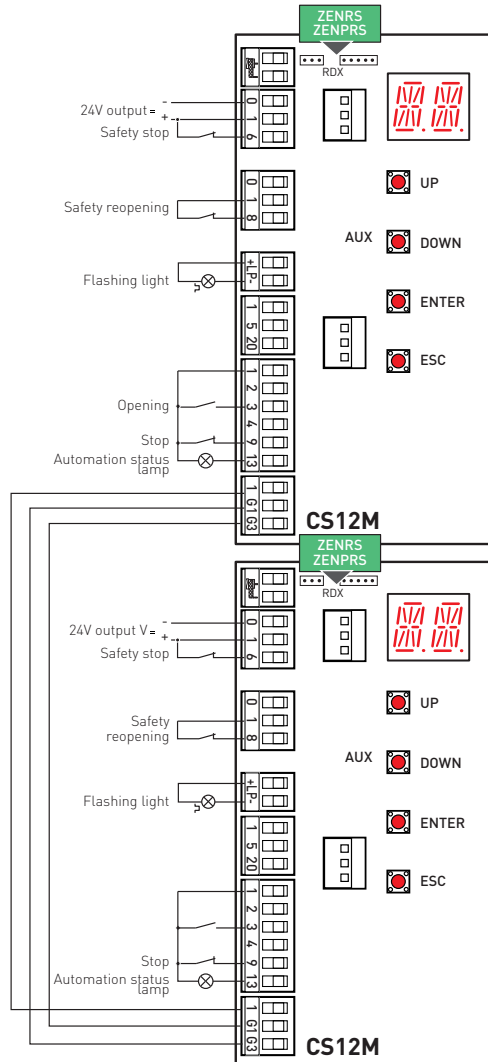

14. Examples of application for interlocked one-way transit automations with presence detection

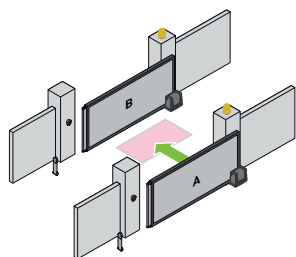

With these settings, command 1-3 starts an opening operation of the MASTER automation which will close after the time set with $BA > TC$ only when the vehicle activates the detection device installed between the two automations (e.g. magnetic loop).

Once the delay time set with $AP > TO$ has elapsed, the SLAVE automation will open and will close after the time set with $BA > TC$. Commands 1-5, 1-4 and 1-20 can be used in special cases, for example, to allow very long vehicles to pass through.

Command 1-9 can interrupt the interlock sequence, i.e., cancel the command given to the SLAVE automation.

1. Disconnect connectors 1-G1-G3 from the control panels.
2. Set the following parameters on both automations via the display: Setting advanced parameters

$AT > AA$ [ENTER] → OK
02°

Setting input mode

$AP > G 1 > 5 Y$

Setting automation parallel mode

$AP > PA > 03$

With this setting the SLAVE automation will not close until contact 1-2 of the MASTER automation is activated.

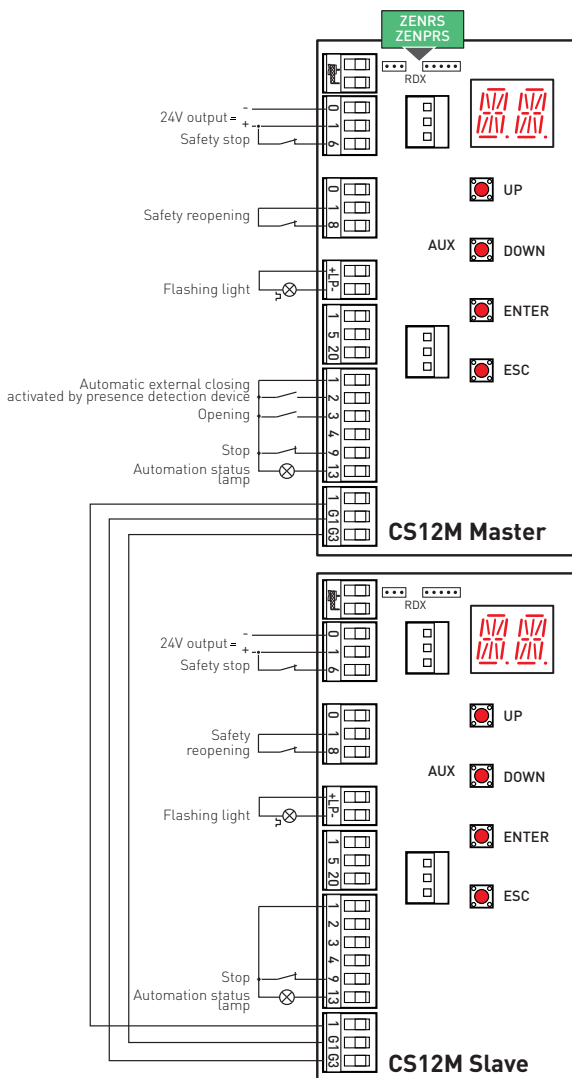

3. Reconnect connectors 1-G1-G3.
4. Set $BC > RM > I-3$ on the MASTER automation.
5. Enable automatic closing on the MASTER automation with $BC > AC > I-2$ and on the SLAVE automation with $BC > AC > ON$.
6. Set the desired automatic closing time ($BA > TC$) on both automations.
7. Although it is not obligatory, we recommend installing only one ZENRS radio receiver - ZENPRS on the MASTER automation.
8. Set the delay time $AP > TO$ (from 0 to 30 s) on the MASTER automation.
9. The reservation function $BC > PG > ON$ can be enabled on the MASTER automation if a vehicle arrives from the same direction while another one is still in transit.
A second opening command is stored and executed as soon as the cycle in progress terminates.

All the rights concerning this material are the exclusive property of ASSA ABLOY Entrance System AB. Although the contents of this publication have been drawn up with the greatest care, ASSA ABLOY Entrance System AB cannot be held responsible in any way for any damage caused by mistakes or omissions. We reserve the right to make changes without prior notice. Copying, scanning or changing in any way is expressly forbidden unless authorised in writing by ASSA ABLOY Entrance System AB.

